

PX-525TD

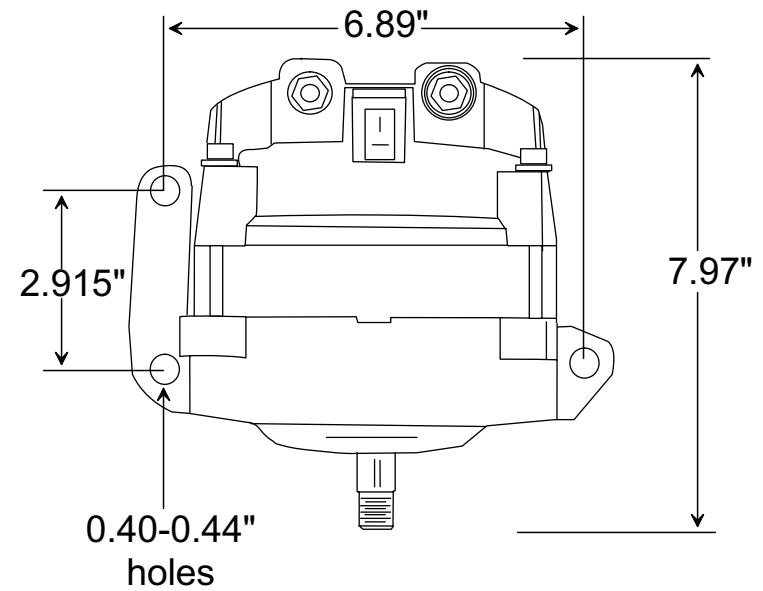
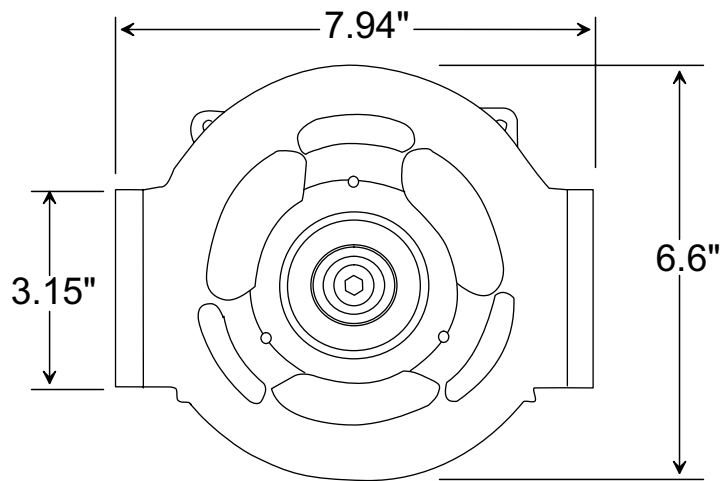
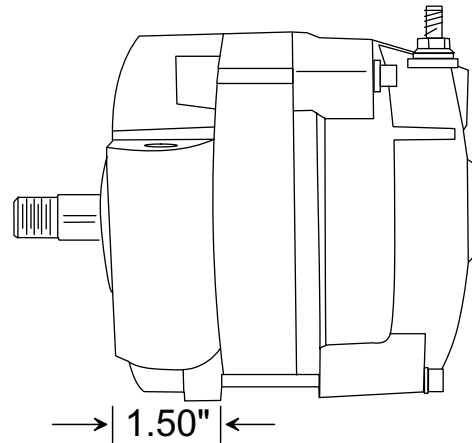

NOTE:

ALL DIMENSIONS ARE LISTED FOR QUICK REFERENCE. CONTACT PENNTEX FOR PRECISE MEASUREMENTS IF REQUIRED FOR BRACKETS OR SPECIAL APPLICATIONS.

PennTex
INDUSTRIES, INC.
DRAWING BY DMc

DATE: 01-08-2008

Scale: None

**PX-5TD-250 ALTERNATOR
FROM PX-525TD KIT,
12 VOLT, 250 AMP,
TANGENT MOUNT**